

Our associates will ensure the tool works properly before you leave the store. If you experience issues with the tool while completing your project, simply bring it back to the Tool Rental Center to get a replacement. If you purchase Damage Protection at the time of your rental, you are not responsible for repair costs for tools that break due to normal use.

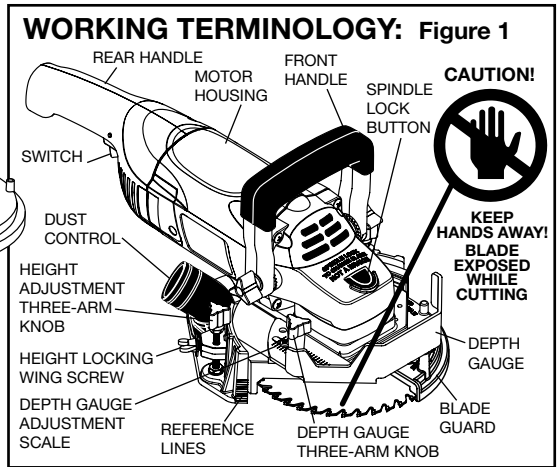

INSTRUCTIONS FOR:

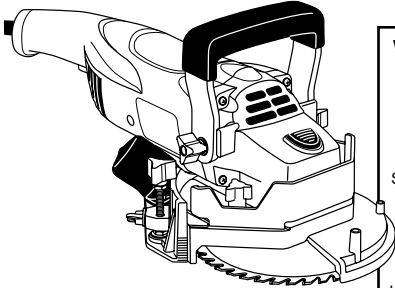

No. 835 Heavy-Duty Undercut Saw

WARNINGS:

- IN USE, KEEP ONE HAND ON THE FRONT HANDLE AND ONE HAND ON THE REAR HANDLE. DON'T REMOVE A HAND TO CLEAR DEBRIS.
- SWITCH OFF AND UNPLUG SAW BEFORE MAKING ANY ADJUSTMENTS, BLADE CHANGE OR REPAIRS. BLADE MUST BE STOPPED.

KICKBACK HAZARDS:

- THE SAW PLUNGE-STARTS. PLUNGE SLOWLY BEFORE PUSHING FORWARD!
- KEEP RPMs HIGH. DON'T FORCE THE SAW, ESPECIALLY WHEN NAILS MAY BE PRESENT.
- HEIGHT ADJUSTMENT: KEEP THE BLADE HOUSING FLAT ON LEVEL FLOORS, AND KEEP BLADE PARALLEL TO THE FLOOR AT ALL TIMES.
- ALWAYS PUSH THE SAW AGAINST THE BLADE ROTATION. NEVER PULL THE SAW TOWARDS YOURSELF OR CUT IN REVERSE.

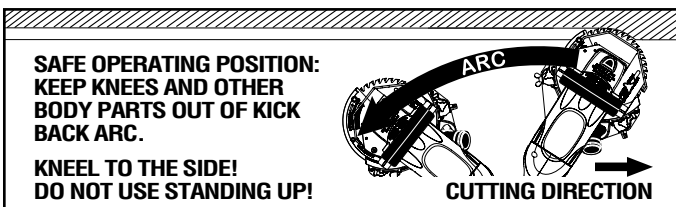

SAFETY FIRST

This saw is designed for undercutting affixed wooden door jambs, moldings, base, and masonry, tile and stone walls to fit new flooring underneath. Do not use this saw for sanding floors, cutting metal, or any purpose not described in this manual.

HANDLES: In use, keep both hands on the handles at all times.

KICKBACK HAZARDS: While cutting, do not force the saw. Keep the housing flat on the floor and the blade parallel to the floor at all times. Angling can cause powerful, dangerous kickback. Keep saw RPMs high. Using a dull blade places a heavy load on the saw and increases danger of kickback. Use only Crain replacement blades.

DUST MASK: Wear approved dust mask or respirator for the material being undercut. See below for further warnings related to dust.

EYE & EAR PROTECTION: Always wear safety glasses and ear protection when using this saw.

BLADE GUARD: The blade guard attached to your saw is for your safety and protection. If it becomes damaged, do not operate your saw until it has been repaired. Keep the blade guard in operating condition when using the saw.

DOUBLE-INSULATED: This saw is constructed with two separate layers of electrical insulation. A tool built with this insulation system does not need to be grounded.

DANGEROUS ENVIRONMENTS: Keep work area clean; clutter invites accidents. Do not use the saw on damp or wet floors. Be sure that there is good lighting. This saw may throw sparks. Make certain that flammable materials, especially explosive vapors, are not present.

ACCIDENTAL STARTING: To avoid accidental starting, do not carry tool while plugged in or with fingers on switch.

CORD ABUSE: Never carry the saw by the cord or yank the cord to disconnect from an outlet. Keep cords away from heat, oil, and sharp edges.

EXTENSION CORD: To minimize power loss and prevent overheating, use extension cord that is a maximum of 25 feet long and with minimum wire gauge 16 AWG.

HAIR & CLOTHING: Keep loose hair and clothing away from the spinning blade at all times.

BLADE REMOVAL: see Figure 2

- Switch off and unplug saw. Blade must be stopped.
- Retract the height adjuster so it is flush with the housing for clearance for wrenches.
- Push the spindle lock button with one hand and insert the hex wrench into the blade screw with the other. Turn the hex wrench until the spindle lock engages the spindle and stops rotation.

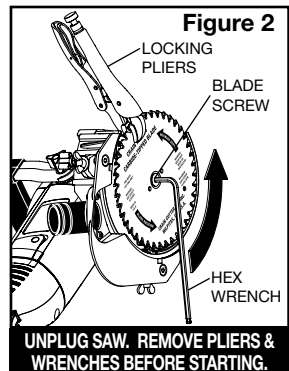

- Hold onto the plastic housing, then push hard on the hex wrench counter-clockwise to open. If the blade is very hard to remove, use a pair of locking pliers to hold the blade, and add an extension tube on the hex wrench for extra leverage.

INSTALLING BLADES - CARBIDE BLADE (#836):

- Switch off and unplug saw. Refer to Figure 3.
- Place blade driver over the spindle (#1835-14) with the inner slot engaged with the spindle.
- Place the blade on top of the blade driver with the two blade driver nubs extending through the two driver holes in the blade.
- Insert and re-tighten the blade screw. Push in the spindle lock to tighten. Tighten firmly before use.

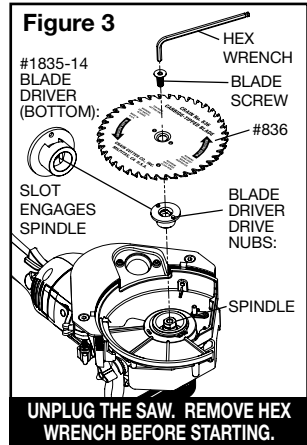

INSTALL MASONRY (#805) OR DIAMOND BLADE (#822):

- Switch off and unplug saw. Refer to Figure 4.
- Place the blade spacer over the spindle.
- Place the blade on top of the blade spacer.
- Place the blade clamp (#1812-P) through the arbor hole of the blade with the bottom slot of the blade clamp engaged with the spindle.
- Insert and re-tighten the blade screw. Push in the spindle lock to tighten. Tighten firmly before use.
- The #822 Diamond Blade is sold separately.

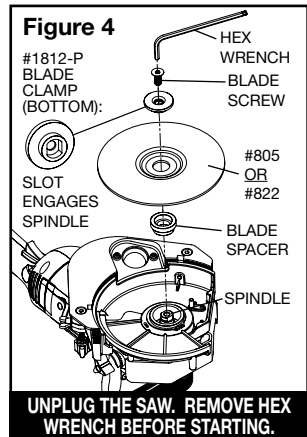

BLADE HEIGHT ADJUSTMENT:

- Switch off and unplug saw. Refer to Figure 5.
- Loosen height locking wing screws 1 to 2 turns.
- Turn the two height adjustment three-arm knobs clockwise to increase blade height and counter clockwise to decrease height.
- It is best to turn both height adjustment three-arm knobs at the same time to ensure the blade is set parallel with the floor.

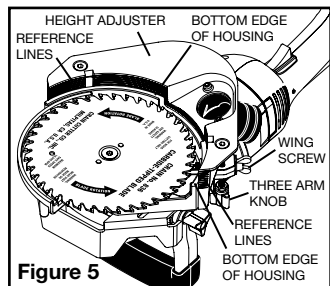

- Both the front of the height adjuster and the inside of the height adjuster have 10 reference lines, in 3/32" increments (.093" which is one blade thickness).

- Maximum height of cut is 1".
- To prevent saw kickback, the blade must be set parallel to the floor. This can be ensured by checking from the front of the saw that, on BOTH sides of the blade housing, the number of lines below the bottom edge of the blade housing are the same (Figure 5), OR by turning the saw over and making sure the bottom edge of the blade housing is completely parallel with a reference line (Figure 6).

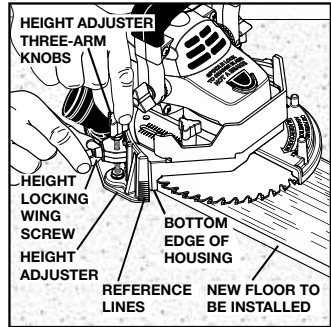

Figure 6

- It may be easiest to set the saw blade flat on top of the new flooring to be fit beneath the desired undercut, and turn the height adjuster three-arm knobs clockwise until the height adjuster rests flat on the floor (Figure 6). From that point, for a snug fit with the new floor, adjust height down by one reference line (one blade thickness).
- Securely tighten the height locking wing screws.

DEPTH ADJUSTMENT:

- Switch off and unplug saw. Blade must be stopped.
- To adjust the depth gauge, loosen the depth gauge three-arm knob. Push the gauge all the way out. A marker on the housing aligns with the shallowest depth gauge increment at 1/8". The gauge includes 13 increments at approximately 1/8" each (Figure 7).
- Retract the gauge as necessary to set the desired depth. Minimum depth is 1/8" and maximum is 1 3/4". We recommend the depth be set to no more than 1/2" to prevent hitting wall studs, nails, etc.

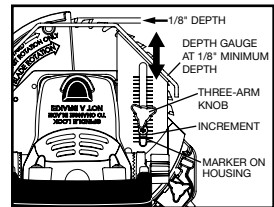

Figure 7

- When undercutting wood base or other trim, set depth to cut the thickness of the wood only (Figure 8). Cutting sheetrock makes dust that damages the saw.
- The depth gauge controls the depth of cut at any of three angles: straight-on (Figure 8), 45° "left" (Figure 9), or 45° "right" (Figure 10).

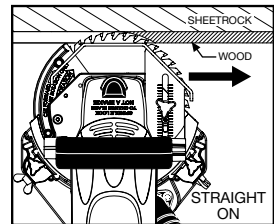

Figure 8

- Cutting at a 45° "left" angle is most efficient for pushing the saw (Figure 9). This is recommended for wood undercutting only using the carbide blade (#836).

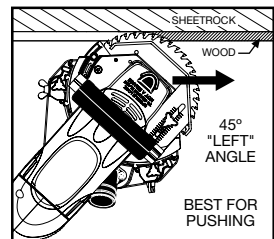

Figure 9

- For dust control, cutting at the 45° "right" angle is preferred. This angle captures as much dust as possible inside the housing. When connecting a vacuum, this angle is the most effective to control dust (Figure 10).

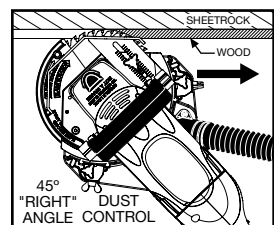
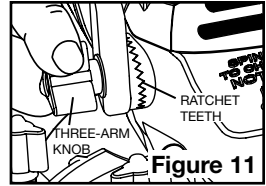

Figure 10

- Re-tighten the depth gauge three-arm knob firmly before use.

USING THE SAW:

- Place the saw flat on the floor near the wall to be undercut. Make certain the blade is set parallel to the floor.
- Make sure the blade holding screw, and height locking wing screws are tightened securely. Make sure the ratchet teeth of the front handle interlock and the three-arm knobs for the front handle are tightened securely (Figure 11).



- Always keep the front handle in the vertical position for general undercutting.

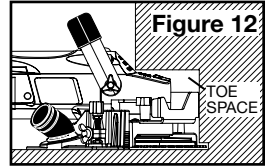

- Lower the handle for undercutting toe spaces (Figure 12). Be sure to retighten the front handle three-arm knobs.
- Plug in the saw and grasp handles firmly with both hands. Keep one hand on the front handle and one hand on the rear handle at all times.
- Depress the safety lock button of the switch, then pull the switch trigger to start the saw.
- To start a cut, use the wall to push the blade guard back and expose blade. **DO NOT USE YOUR HAND!**
- First, plunge slowly to appropriate depth. Second, push the saw forward. Move the saw from left to right only. Don't force the saw. Let blade cut at highest RPM possible. Do not pull the saw towards you or run in reverse. Do not lift or angle the saw, or saw kickback may result.
- Remove the saw from the cut, and release the switch to stop.

INSIDE CORNER CUTTING:

- When undercutting wood, cut towards the corner at 45° "left" angle (see Figure 13) until the depth gauge meets the right wall (see Figure 14). Otherwise, cut on the 45° "right" angle with dust control (see Figure 10).
- Stop and unplug saw. Fully retract depth gauge and continue the cut.
- Push saw into the corner (see Figure 15).

WARNING: Depth gauge covers the blade and makes the saw safer to use. Always unplug the saw and reset the depth gauge when inside corner cutting is complete.

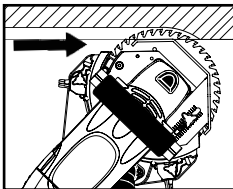

Figure 13

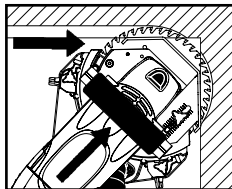

Figure 14

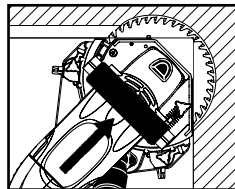

Figure 15

DOOR CUTTING: see Figure 16

- Open the door to the maximum, away from the casements. Work from the inside of the door outward, away from the hinges. To avoid splintering veneer doors, it may be advisable to score the veneer surface at the desired height of the cut, prior to using the saw. An application of wide masking tape covering the area above and below the expected saw kerf also helps reduce splintering, and can protect from the saw housing scratching the veneer. **DO NOT MOVE OR LIFT DOOR WHILE CUTTING OR KICKBACK MAY RESULT!**

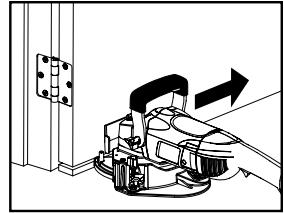

Figure 16

- NOTE: The maximum depth of cut is 1¾", which is adequate for most doors. Check for adequate depth of cut before starting. Thicker doors may require cuts from both sides of the door. Take care not to leave a thin remnant of door on the opposite side, which can easily break off and crack the veneer. Also, check that the floor is at the same elevation on both sides of the door, or additional height adjustment may be required.
- The maximum height of cut is one inch. To cut off higher than one inch, place a flat sheet of plywood underneath the saw.

POCKET DOOR CUTTING:

- Take precautions necessary for veneer doors and check door thickness as described above (under "Door Cutting"). Pocket door cutting requires two people. One must hold the saw down and in a fixed position, while the other person slowly pulls the door into the blade. **DO NOT LIFT DOOR OR THE SAW WHILE CUTTING OR KICKBACK MAY RESULT!**

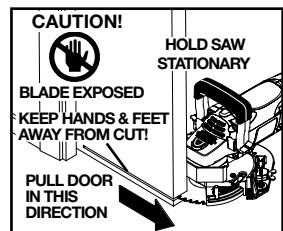

Figure 17

- Remove any unfinished area at the bottom of the pocket door with a hand saw, following along in the pre-established cut.

MASONRY, STONE, OR TILE UNDERCUTTING:

- The No. 805 Masonry Blade is primarily used for cutting brick. It is not for use on tile or stone. Use the No. 822 Diamond Blade (accessory) for cutting brick, tile or stone.
- Masonry, stone, and tile undercutting creates a lot of dust. Use the dust control port with a vacuum and cut on the 45° "right" angle (Figure 18). Wear an approved dust mask or respirator (see below for further warnings related to dust). Place a light cloth over the air intake of the saw to prolong the life of the saw.

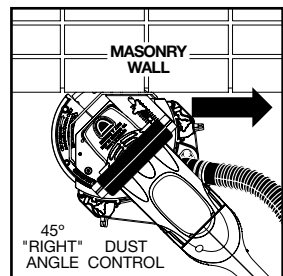

Figure 18

- **DO NOT** use this saw for cutting steel or aluminum. Sparks can cause fire in the wall behind the door casing.

MAINTENANCE:

If the saw is dropped, the blade guard may be bent or otherwise damaged, restricting full return. Sawdust that accumulates behind the blade guard can cause it to become jammed open or closed, especially drywall dust. Check operation of the blade guard before each use. Do not use the saw if the blade guard does not operate properly. When not in use, store the saw in the custom carrying case. The saw motor may run even if the switch malfunctions, causing the motor to not switch off. Do not use the saw if the switch malfunctions. Repair the switch immediately!

SPECIFICATIONS:

Voltage:	120VAC, 60 HZ.
Construction:	Double Insulated
Plug Type:	2 Pin US Plug
Amperes:	13 Amps
Wattage:	1500 Watts
No Load Speed:	6,500 RPM
Max Depth of Cut:	1¾"
Max. Height of Cut:	1"
Toe Space Cutting - Minimum Height:	4½"
Gross Weight:	21.5 LBS.
Replacement Blades:	#836 Carbide Blade, #805 Masonry Blade, #822 Diamond Blade.

WARNING:

Some dust created by power sanding, sawing, grinding, drilling, and other construction activities contains chemicals known to the State of California to cause cancer, birth defects or other reproductive harm. Some examples of these chemicals are:

- lead from lead-based paints,
- crystalline silica from brick, cement and other masonry product, and
- arsenic and chromium from chemically-treated lumber.

Your risk from these exposures varies, depending on how often you do this type of work. To reduce your exposure to these chemicals: work in a well-ventilated area, and work with approved safety equipment, such as those dust masks that are specially designed to filter out microscopic particles.

WARNING: grinding, cutting, or drilling of stone, masonry, brick, concrete, metal, ceramic tile and other materials with silica in their composition may give off dust or mists containing crystalline silica. Silica is a basic component of sand, quartz, brick clay, granite, marble and numerous other minerals and rocks. Inhalation of airborne crystalline silica can cause serious or fatal respiratory diseases, including silicosis. Use OSHA and NIOSH approved dust monitoring, dust control, dust collection and respiratory protection equipment and methods, and follow all applicable regulations.

